

FAS

Framing Anchor

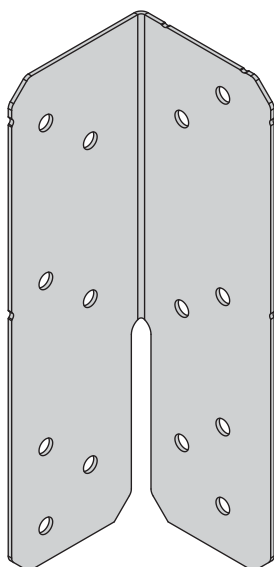

The FAS is an adjustable connector for providing a positive fixing on two planes.

Features & Benefits

- Eliminates damage from skew nailing
- Adjustable bend to accommodate various applications

Material Specification

- Galvanised mild steel - Z275

Fixings

Code	Description	Box Qty
547389	3.4 x 35mm Square Twist Nails - LOOSE	500
141185	3.4 x 35mm Square Twist Nails - COLLATED*	2,500

*For use with Paslode PPN35Ci

Dimensions (mm)

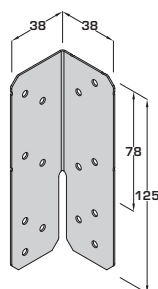

In Situ

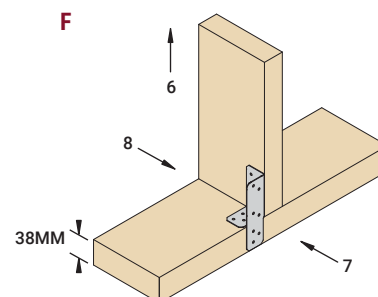
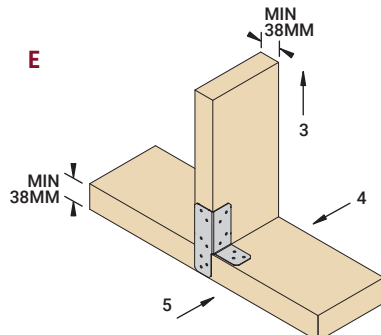
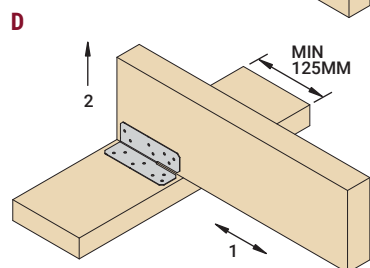
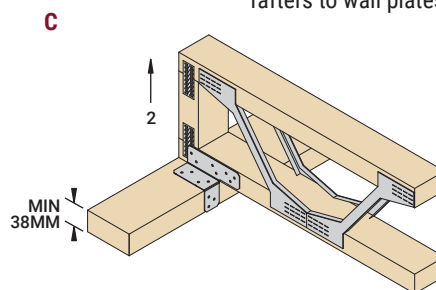
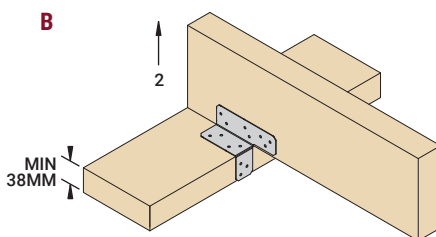
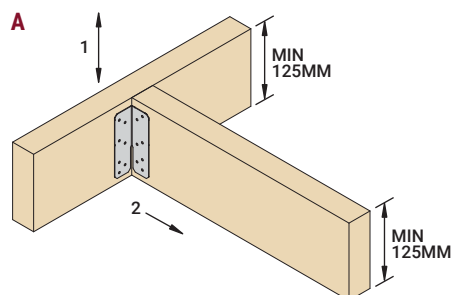

Suitable for fixing Open Web / I-Joist flat rafters to wall plates

Load Data

Product Code	Fixings (3.4 x 35mm)		Load Direction	Characteristic Capacity (kN) - Per Pair of Anchors
	Header	Incoming		Solid Timber Header (Min TR26)
FAS	7	7	1	5.83
			2	3.40
			3	8.10
	6	8	4	3.35
			5	1.44
	6	4	6	8.10
			7	1.16
			8	0.89